

# VB

## ACCESSORI PER FILTRI PISCINE - SCARICO DI FONDO ACCESSORIES FOR SWIMMING POOL FILTERS - BOTTOM DRAIN



- Disponibile con Attacco Rapido e Portagomma per tubo.

- Dotati di Otturatore interno per chiusura rapida e scarico.

- Available with Quick Connector and Hose Adapter.

- Equipped with internal shutter for fast closing and discharge.

Presca esagonale SW10 per bloccaggio ugello dall'esterno  
SW10 hexagonal socket for nozzle locking from outside

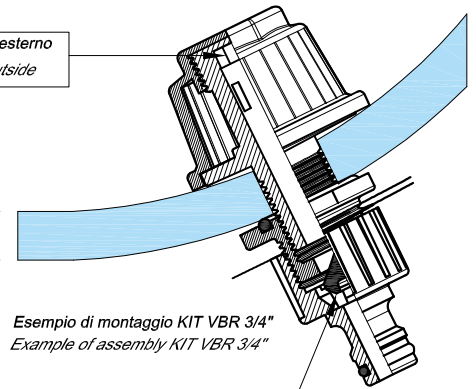

Esempio di montaggio KIT VBR 3/4"  
Example of assembly KIT VBR 3/4"

Otturatore per chiusura rapida e scarico  
Shutter for fast closing and discharge

PVB

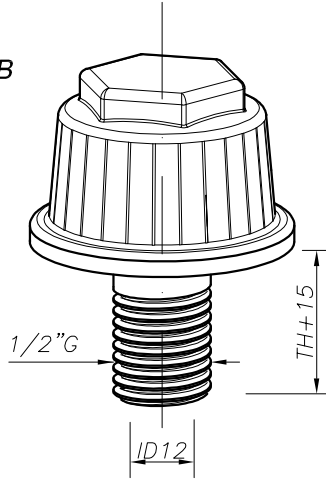

OS 50x22x2.5 - EPDM

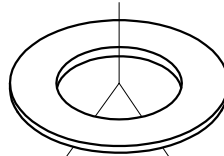

OR 4100

OR 4100

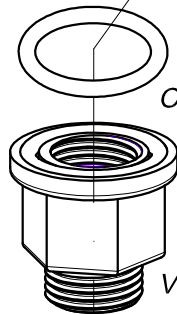

VB01

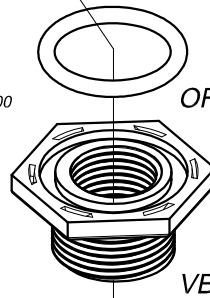

VB03

OR 119

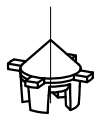

VB10

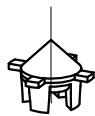

VB10



VB10

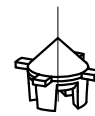

VB10

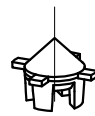

VB10

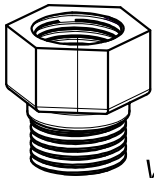

VB02



VB07

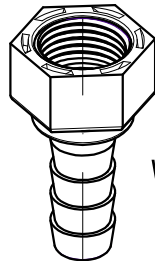

VB06

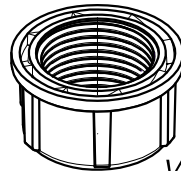

VB08

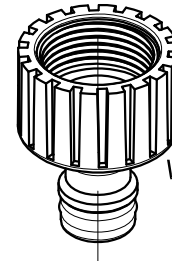

VB05

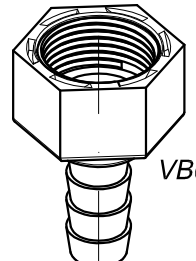

VB04

KIT VBA

KIT VBR 1/2"G

KIT VBP 1/2"G

KIT VBC 3/4"G

KIT VBR 3/4"G

KIT VBP 3/4"G

Come ordinare How to order	KIT	TH - Spessore parete wall thickness	Fessura Slot	Contenuto Content
Esempio Example	VBR 3/4	20	0,50	PVB NOZZLE + GASKET OS OR + VB03 + VB10 + VB05

Materiale Material	PVB Nozzle	
	VB01-VB02-VB10-VB04-VB06	PP
	VB07 - VB05	PPFV
		ABS