

MP Manicotti soft - Accessori di fissaggio per piastra

Soft sleeves - Fixing accessories for plate

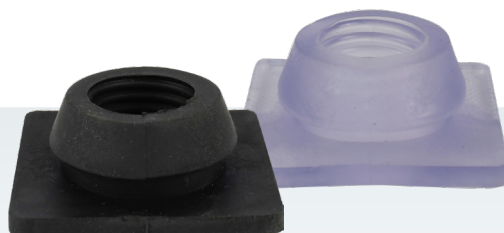

- Adatti per l'installazione su filtri con lato inferiore piastra portagelli inaccessibile

- Suitable for filters where access to the underside of the nozzle plate is not possible

Materiale

Material

PVC

EPDM
black

Modello Model	Spessore piastra Plate thickness mm	Filetto Thread	Foro piastra ø Plate hole ø mm	Ht - Altezza manicotto Ht - Sleeve height mm
MP03	3	15/16"W	31,5 - 32,0	19
MP05	5	15/16"W	31,5 - 32,0	19
		1 1/4"W	37,0 - 37,5	
MP7.5	7 - 8	15/16"W	31,5 - 32,0	19
		1 1/4"W	37,0 - 37,5	
MP10	10	15/16"W	31,5 - 32,0	22
		1 1/4"W	37,0 - 37,5	
MP15	15	15/16"W	31,5 - 32,0	26
		1 1/4"W	37,0 - 37,5	
MP25	25	15/16"W	31,5 - 32,0	36
		1 1/4"W	37,0 - 37,5	

ORDINE - ORDER

Modello Model	Filetto Thread	Materiale Material
MP10	15/16"W	PVC

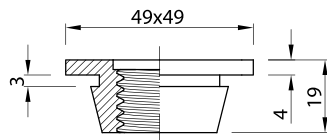
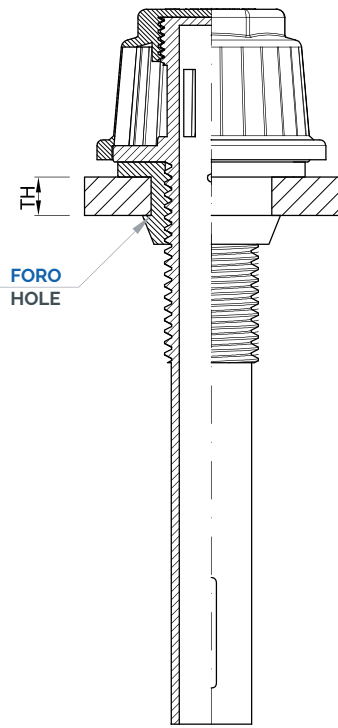

MP03

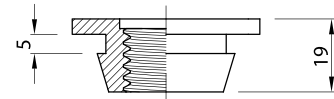

MP05

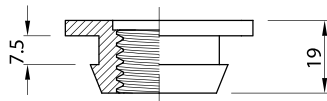

MP7.5



MP10

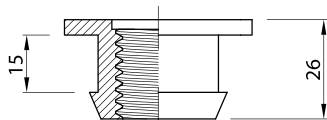

MP15

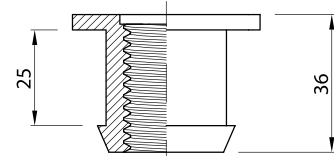

MP25

I fori della piastra dovranno essere smussati per evitare danni all'articolo.
The plate holes must be chamfered to avoid item damage.

