

RBD2 - RBD3

DISTRIBUIDORES 2" G - 3" G DISTRIBUTORS 2" G - 3" G

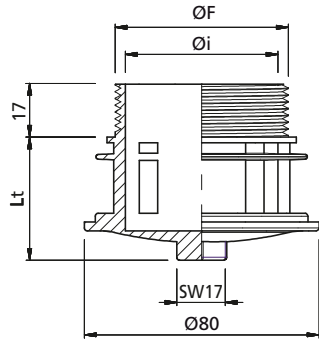

- Sistemas de distribución superior para filtros de arena y carbón activo
- Upper distribution systems for sand and activated carbon filters



RBD2

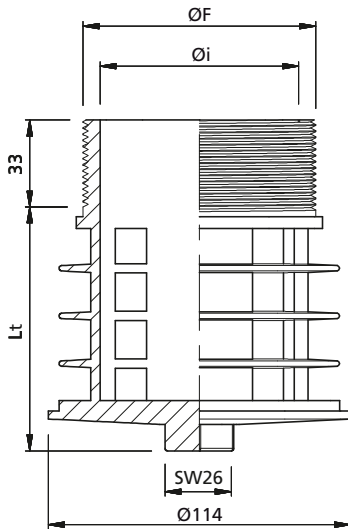
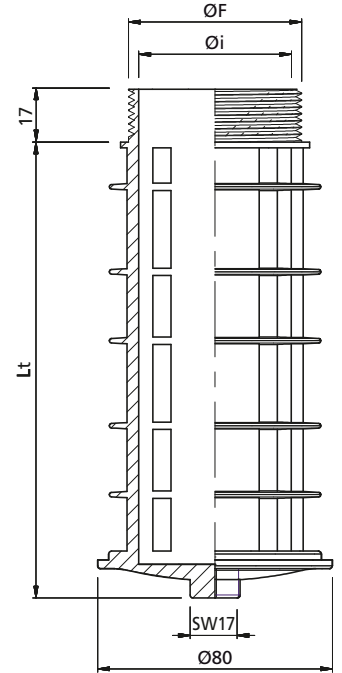
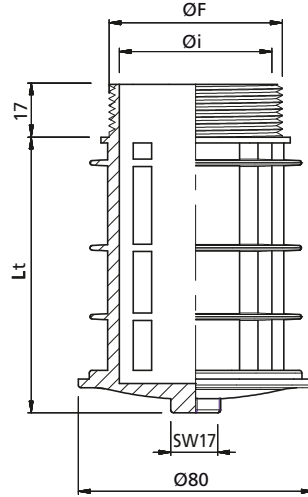

RBD3

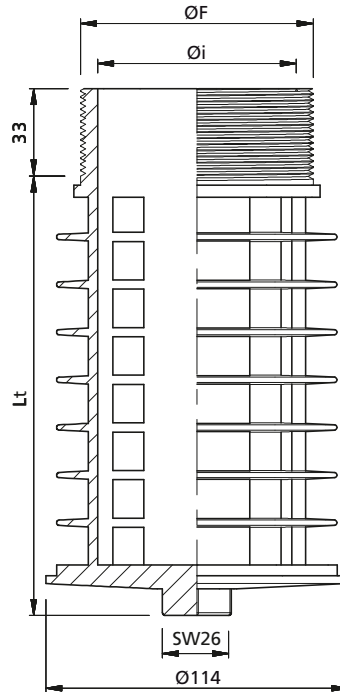

Tipo Type	ØF Rosca Thread	Øi mm	Lt mm	Área Ranuras Slot Area mm ²
RBD2	2" G	52	45	788
		52	95	2480
		52	155	4500
RBD3	3" G	75	90	3808
		75	160	7890
		75	235	12000

Material/Material:	PP
--------------------	----

Cómo pedir How to order	Distribuidor Distributor	Lt	Material Material
Ejemplo / Example	RBD 3	168	PP

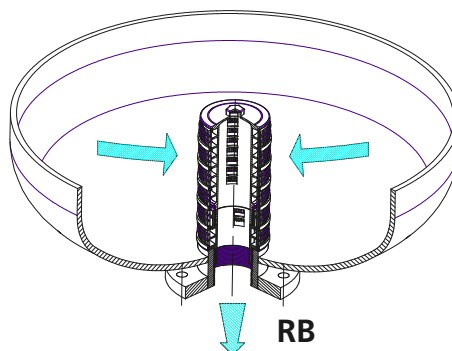

RB
Drenaje inferior
Bottom drain

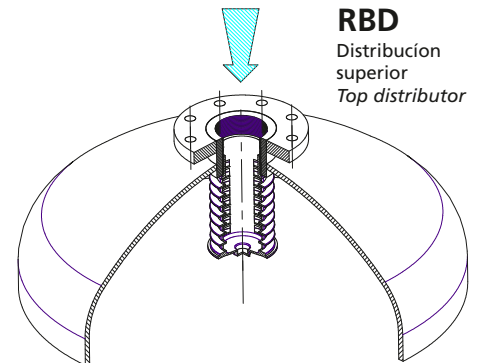

RBD
Distribución superior
Top distributor